

## 2 Gang Touch Switch White/Black

- What you need to get started
- HomeMate 2 Gang Touch Switch.
- Phone must be connected to 2.4 Ghz WiFi network only (and not 5 Ghz).
- Location should be ON.
- Mobile Bluetooth should be ON.

## 2 Gang Touch Switch Connection Diagram

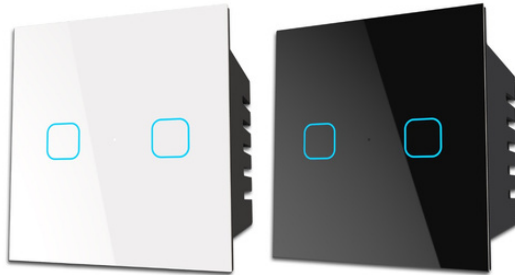
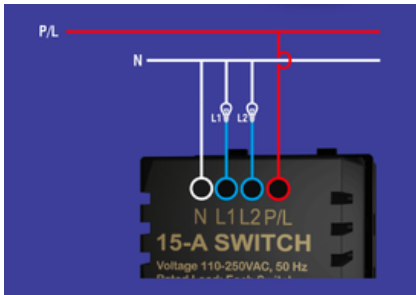

## 4 Gang Touch Switch Connection Diagram

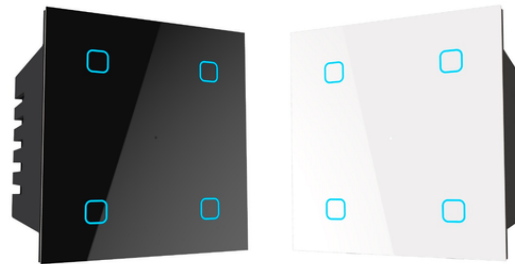
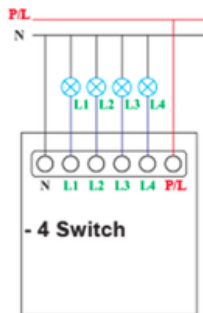

## Smart Fan Regulator Touch Switch Connection Diagram

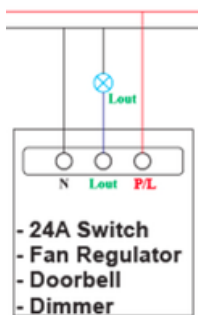

### Touch switch 24A Connection Diagram

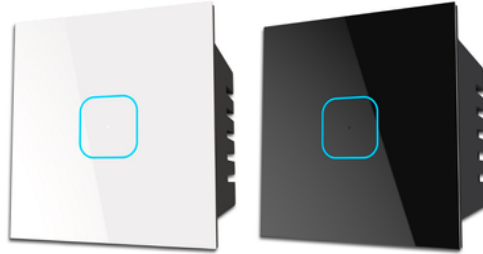
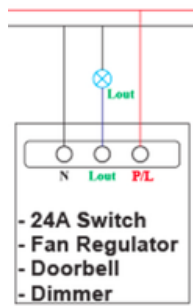

### HomeMate Touch Curtain Switch Connection Diagram

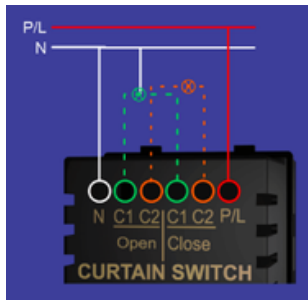

**Note: ON/OFF operating principle: The connected appliances work/stop through live wire power ON/OFF .CAUTION : RISK OF ELECTRONIC SHOCK OR BURNS - USE IN DRY LOCATION ONLY.**

**Do not use outdoors, with wet hands, or when standing on wet or damp surfaces.**

**Switch off the main supply while making connections.**

- 1.Installation must be carried out by a qualified electrician in accordance with local regulations.
- 2.Keep the device away from water, damp or hot environment.
- 3.Install the device as per given instruction.
- 4.Turn off the power supply before carrying out any electrical installation work.
- 5.Connect wires according to the wiring diagram.
- 6.Insert the module into the junction box.
- 7.Connect the power supply and follow Wi-Fi switch module configurations instructions.

#### **Pairing of HomeMate 2 Gang Touch Switch with HomeMate Smart app**

- 1.After giving input and Load connection to the HomeMate 2 Gang Touch Switch check if the center LED is blinking. If it is not blinking, follow the below steps.
- 2.After connecting the device as mentioned above installation process, Long Touch any touch switch for 20s until the center LED will start Blinking that means it is now in pairing mode.
- 3.Connect your mobile with home Wi-Fi(2.4Ghz).
- 4.Bluetooth and location must be On.
- 5.Open the HomeMate Smart App.
- 6.Tap '+' at the top right corner or 'Add device' button on the Home screen.
- 7.It will automatically show the nearby device ready to be paired.
- 8.Tap on "Go to add"
- 9.Tap '+' at the top right corner to add the device.
- 10.Enter Wi-Fi Password then tap on "Confirm".
- 11.It will connect to the HomeMate 2 Gang Touch Switch.
- 12.After adding you can edit the name of the HomeMate 2 Gang Touch Switch.
- 13.Tap on pencil mark located after 2 Switch.
- 14.Type the desired name like "Bedroom Switch" tap on "Save" then tap on "Done" located on the Top right corner.